

ANLEITUNG DIY MONSTA BAG

BY THORSTEN BERGER
EXKLUSIV FÜR SWAFING



ÜBERSICHT

PANELDESIGN EXEMPLARISCH | CA. 10 MM NAHTZUGABE ENTHALTEN



TRÄGER

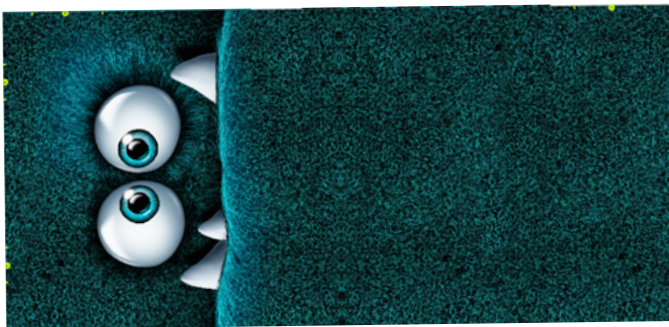

MONSTA AUSSENTASCHE



MONSTA INNENTASCHE

MATERIALLISTE

- NÄHEQUIPMENT
- SCHERE, STECKNADELN, NÄHNADEL
- BLEISTIFT ODER FINELINER
- SICHERHEITSNADEL
- ETWAS FÜLLWATTE O.Ä.
(FÜR 3D-EFFEKT BEI DEN HÖRNERN)

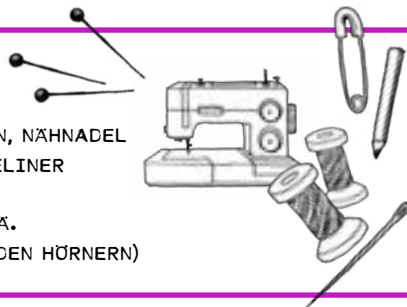

MONSTA HÖRNCHEN



OPTIONAL:
MÖGLICHE
INNENTASCHE/N
ODER, ODER,
ODER :-)



OPTIONAL:
LABEL ZUR
PLATZIERUNG
AN DER SEITE

DARSTELLUNGSHINWEISE

RECHTE STOFFSEITE
(BEDRÜCKT)



LINKE STOFFSEITE
(UNBEDRÜCKT WEISS)



NÄHTE MIT GERADSTICH

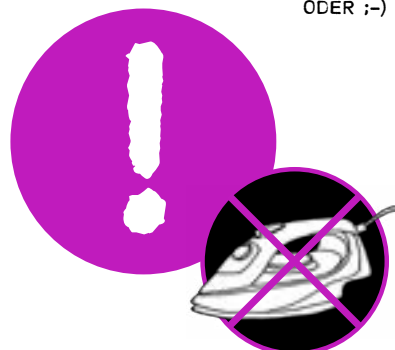
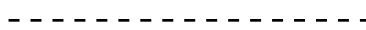

PLATZIERHILFE

MARKIERUNGEN DER ELEMENTE FÜR EINFACHES ZUSAMMENFÜGEN



BEISPIEL
HORN /
ELEMENT „H”

GLEICH BEZIFFERTE ELEMENTE
GEHÖREN ZUSAMMEN UND WERDEN
JEWEILS ENTSPRECHEND DER
ANLEITUNG VORBEREITET/ZUSAM-
MENGEÄHT

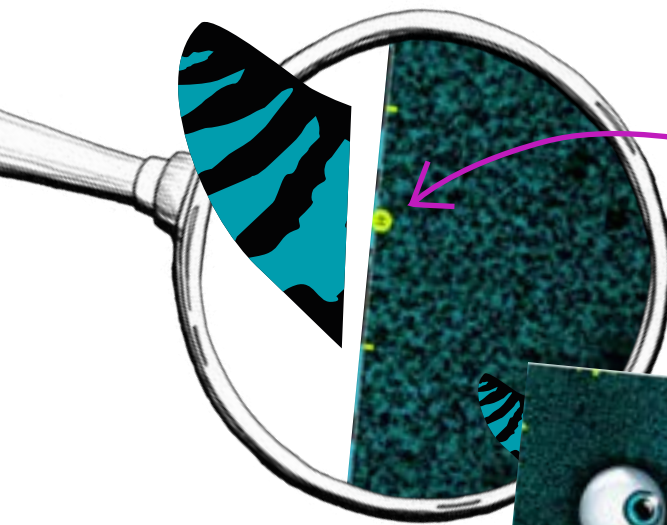

DAS VORBEREITETE
ELEMENT „H” GEHÖRT
ZWISCHEN DIE MARKIE-
RUNGSSTRICHE „H”



SO HAST DU IMMER EINE KLEINE
ORIENTIERUNG BEIM ZUSAMMENFÜGEN,
DAMIT AM ENDE ALLES MONSTAMÄSSIG
ZUSAMMENPASST.



HÖRNER VORBEREITEN

EINE ECHTE MONSTA BAG BRAUCHT HÖRNER.

1

HÖRNER
PAARWEISE
ZUSAMMEN-
SUCHEN



2

RECHTS AUF
RECHTS
ÜBEREIN-
ANDERLEGEN

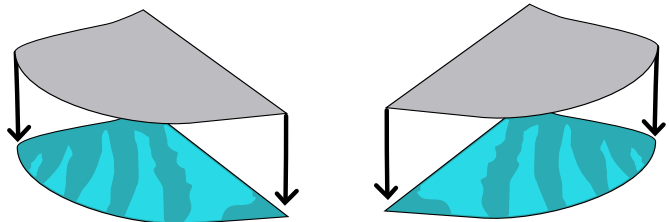

3

DECKUNGS-
GLEICH
FIXIEREN

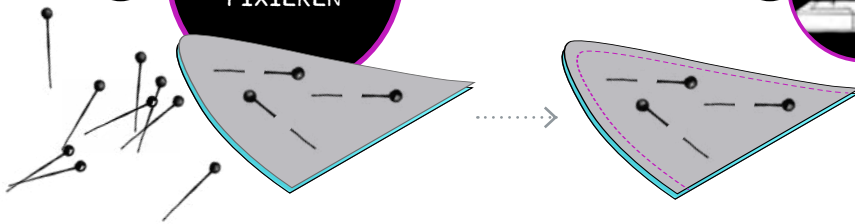

4

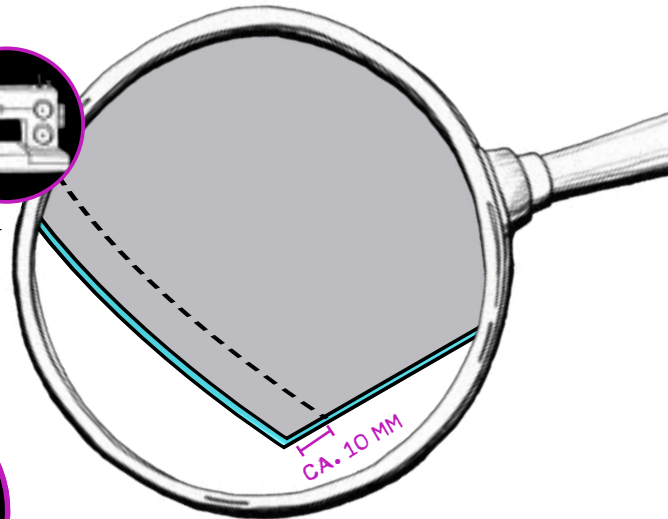

5

NAHTZUGABE
MEHRFACH
VORSICHTIG
EINSCHNEIDEN.

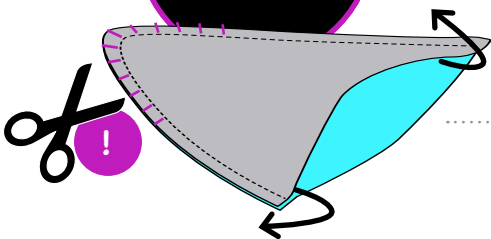

6

KOMPLETT
WENDEN.

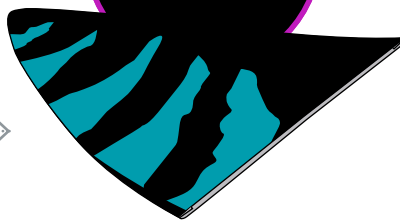

7

ELEMENTE
LEICHT
WATTIEREN

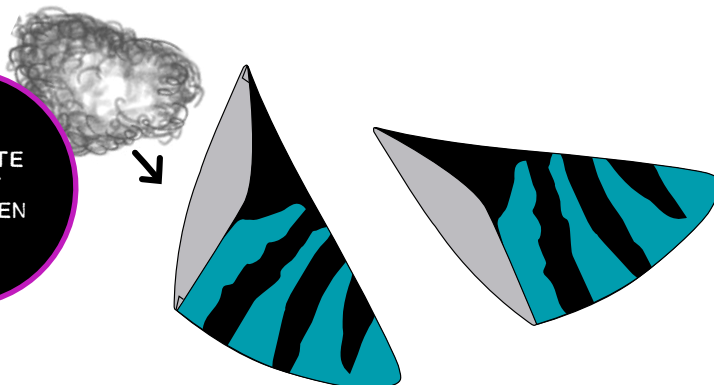

TRÄGER

HABEN DIE TRAGENDE ROLLE BEI DER MONSTA BAG :-)

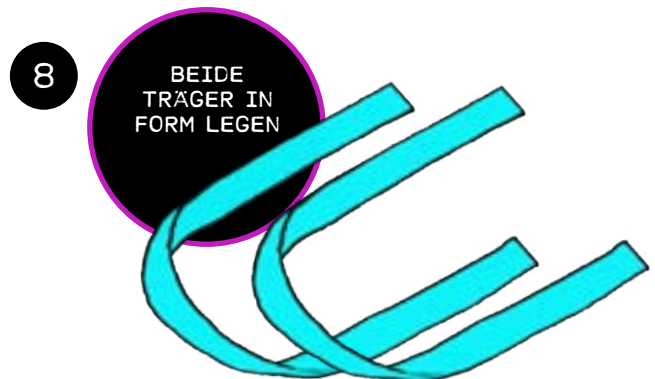
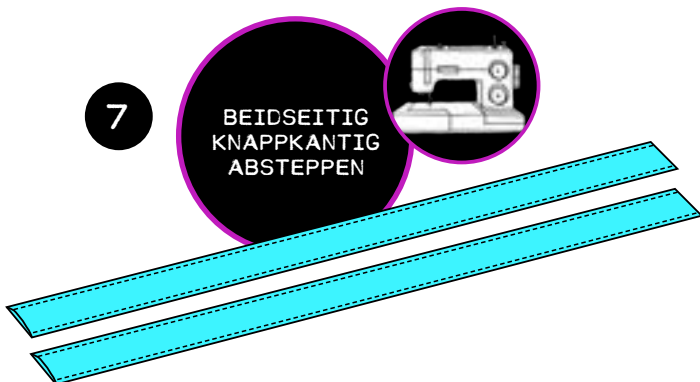
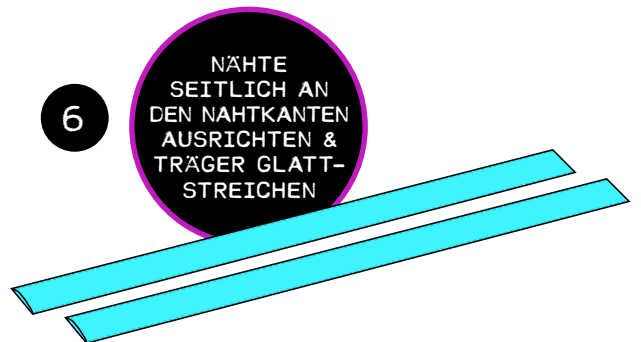
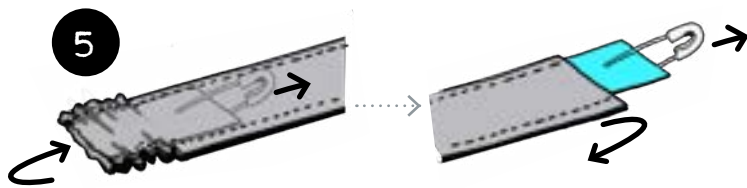
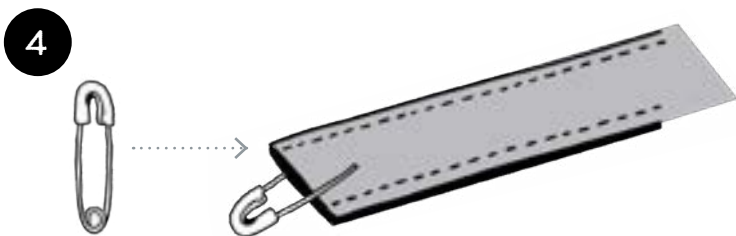
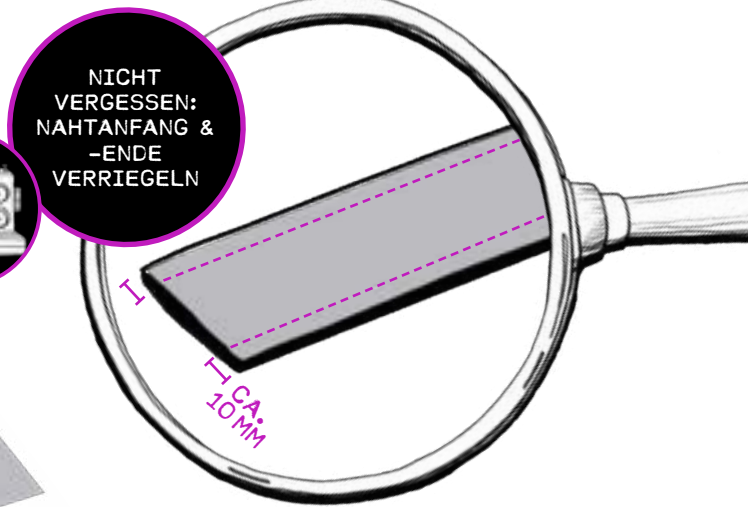
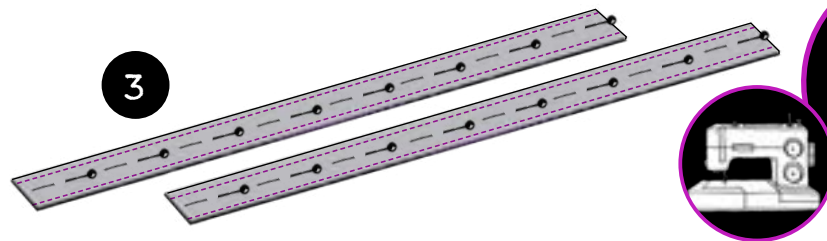
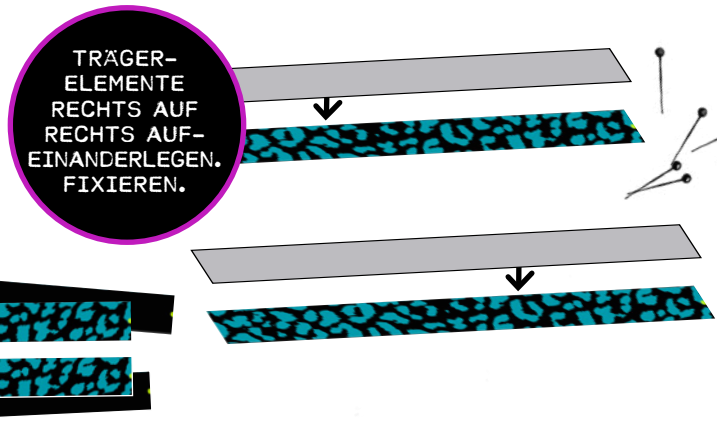
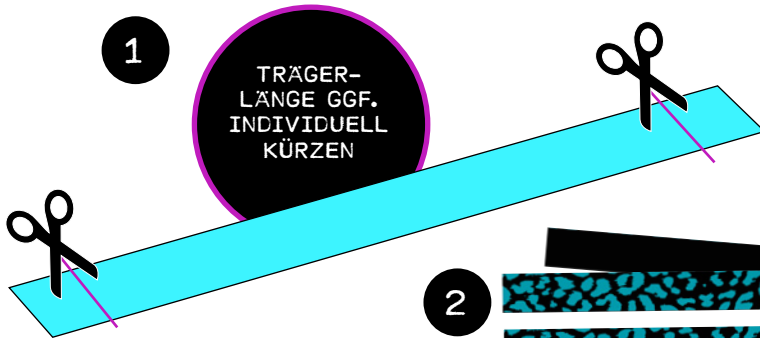

LABEL VORBEREITEN

OPTIONAL: VERSCHIEDENE LABEL

1
OPTIO-
NAL



2



CA. 10 MM

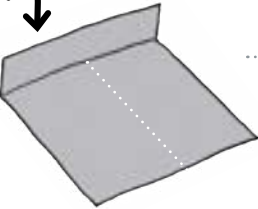

3

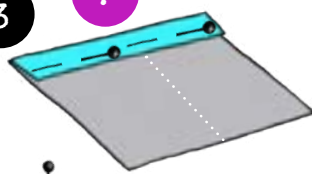
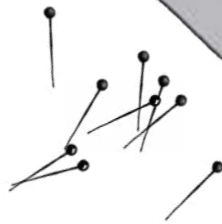

4

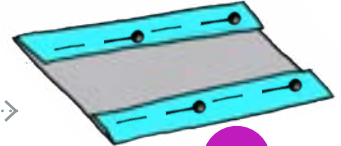

5

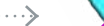
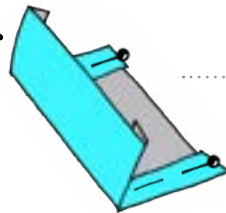

6

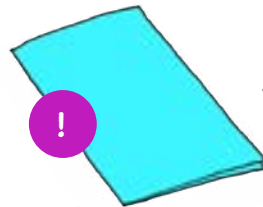

7

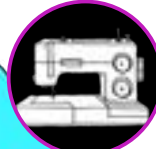
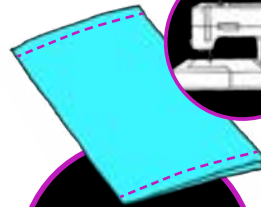

MÖGLICHST
KNAPPKANTIG
AN SEITEN
NÄHEN

INNENTASCHE/N

DIES IST NUR EINE OPTION - VIELLEICHT FÄLLT DIR JA AUCH WAS GANZ ANDERES EIN!?

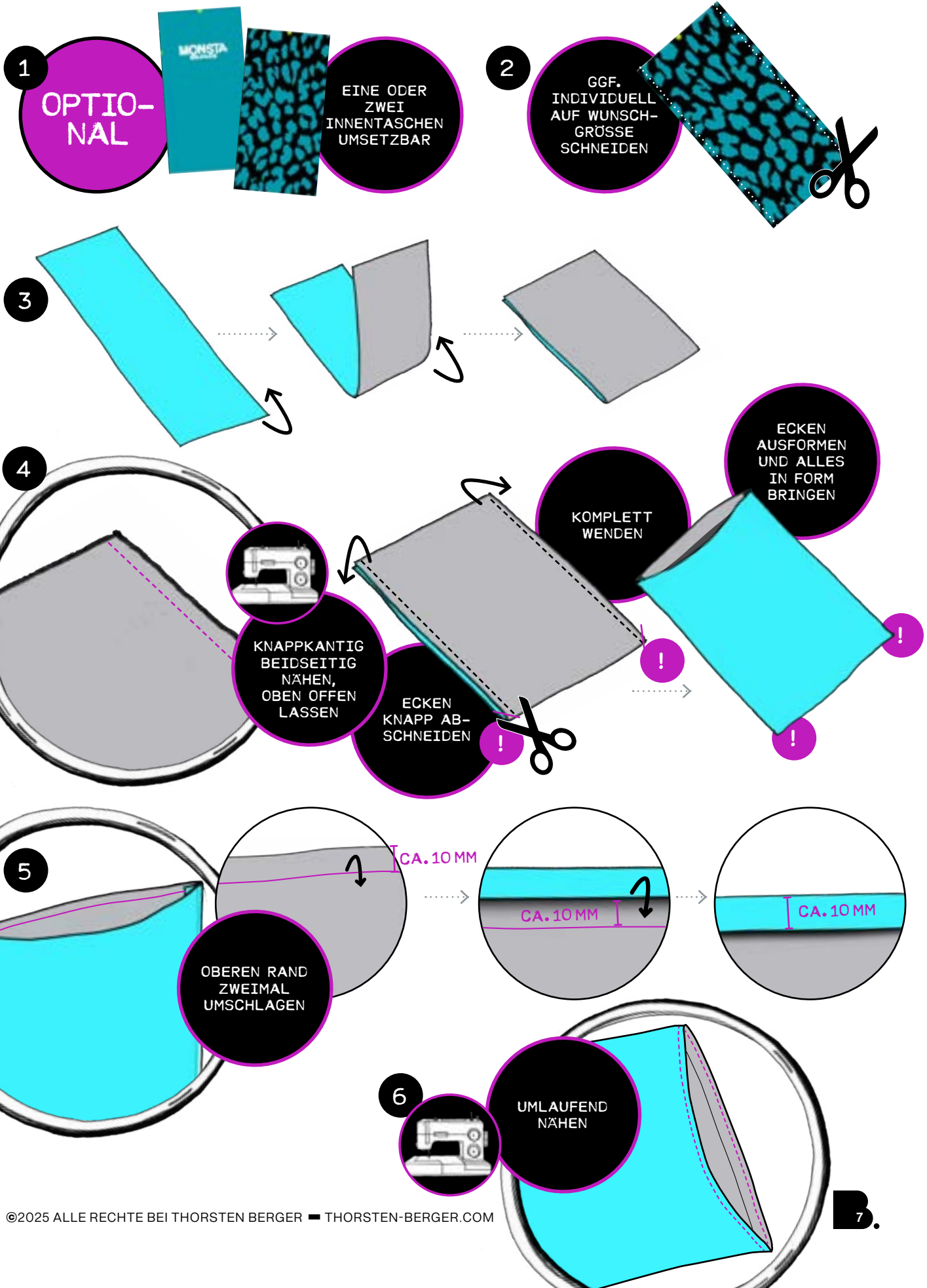

MONSTA BAG

AUSSENTASCHE FÜR EINEN MONSTAMÄSSIGEN AUFTRITT :-)

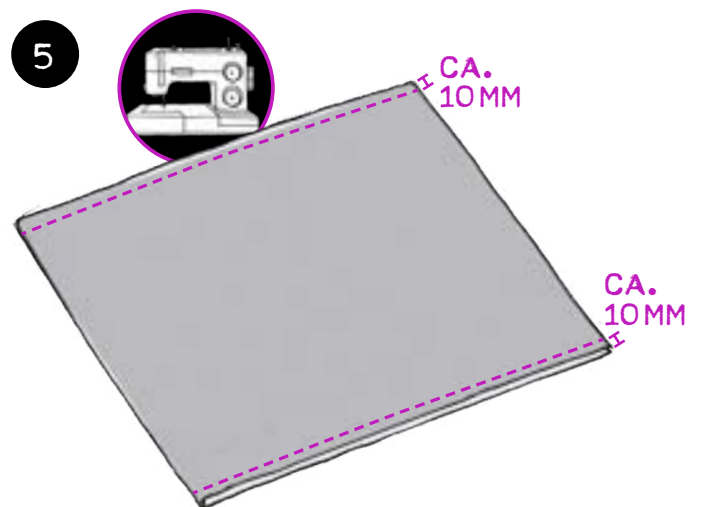
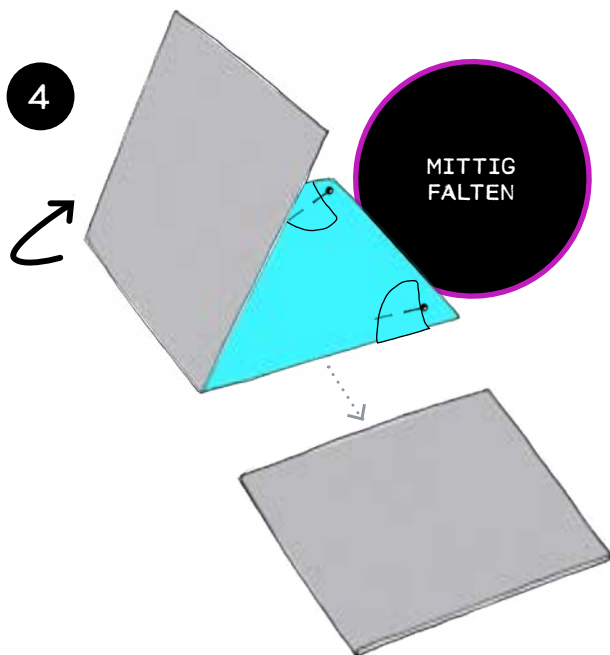
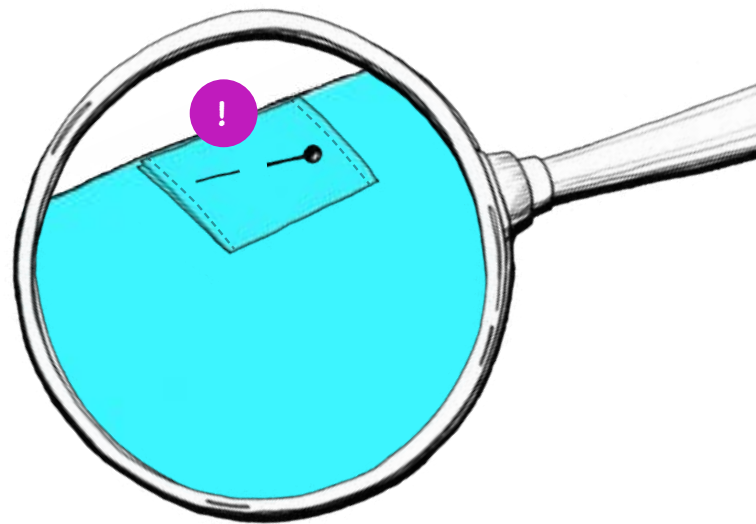
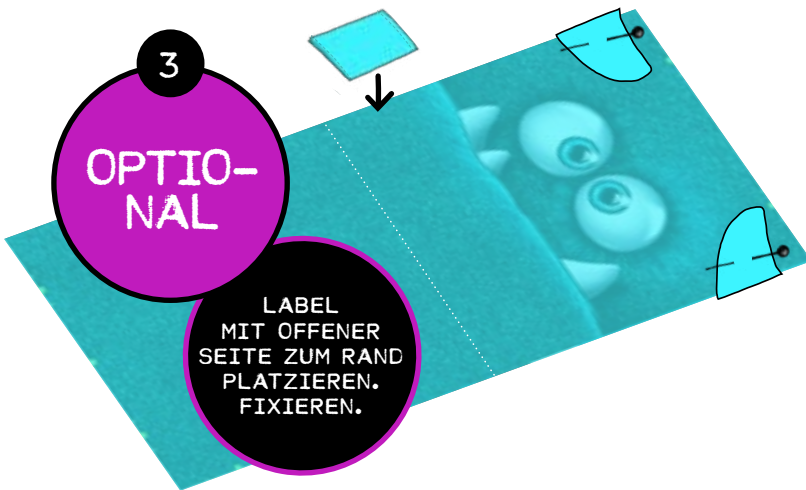

MONSTA BAG

AUSSENTASCHE FÜR EINEN MONSTAMÄSSIGEN AUFTRITT :-)

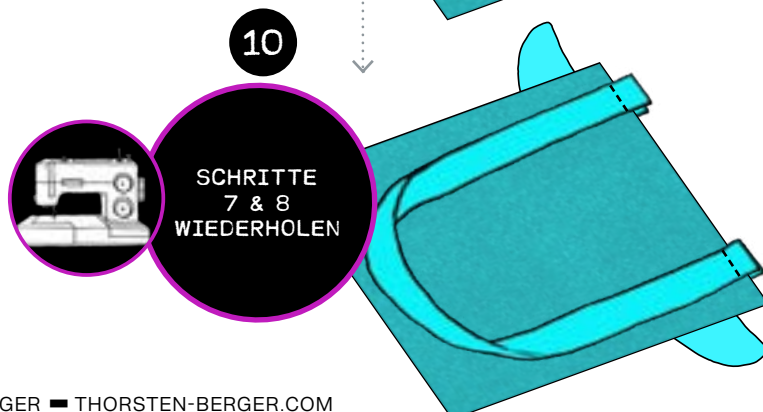
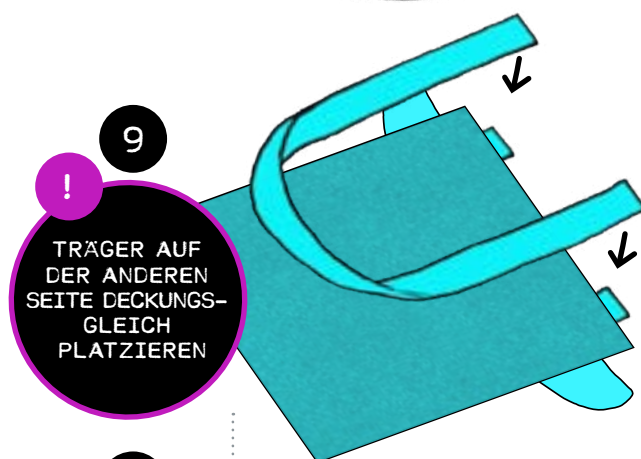
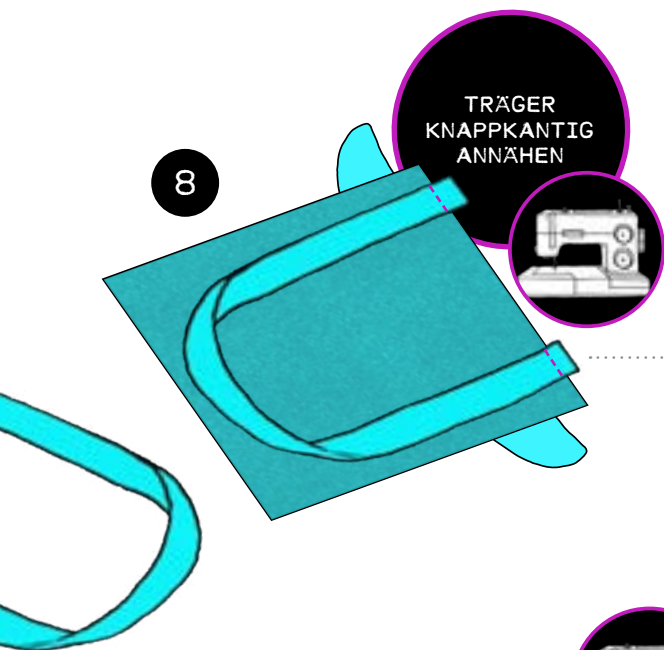
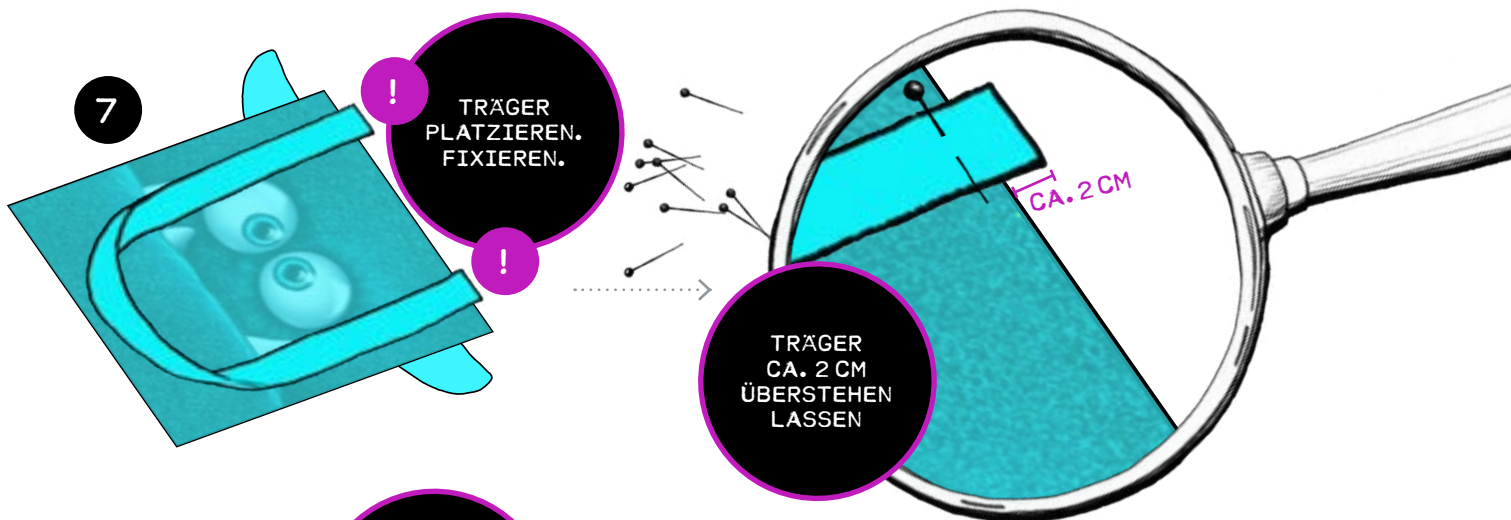
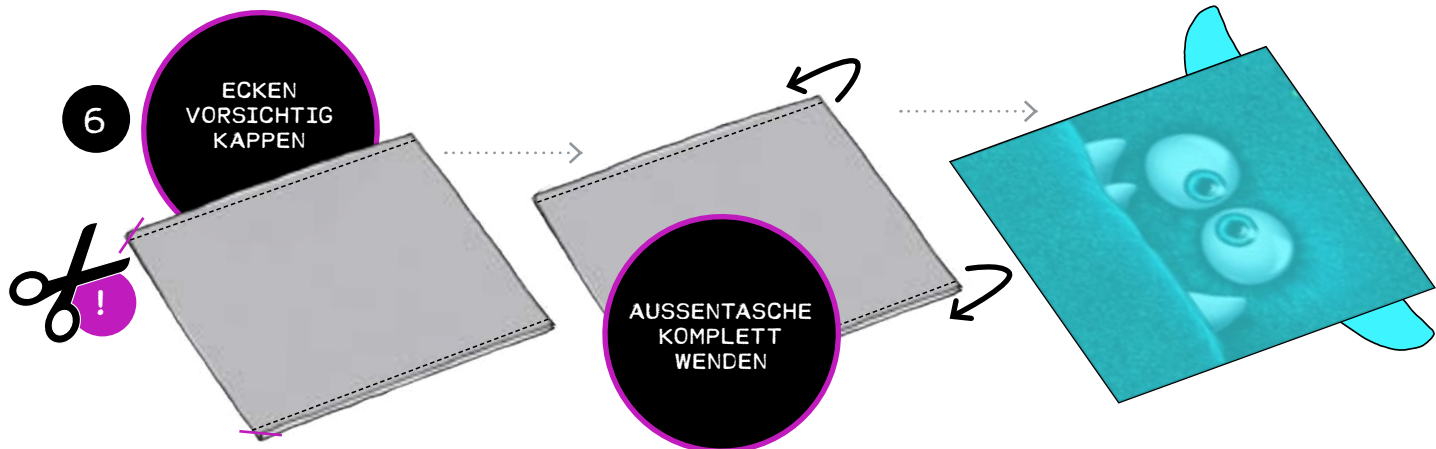

MONSTA BAG

INNENFUTTER IM MONSTA-LOOK

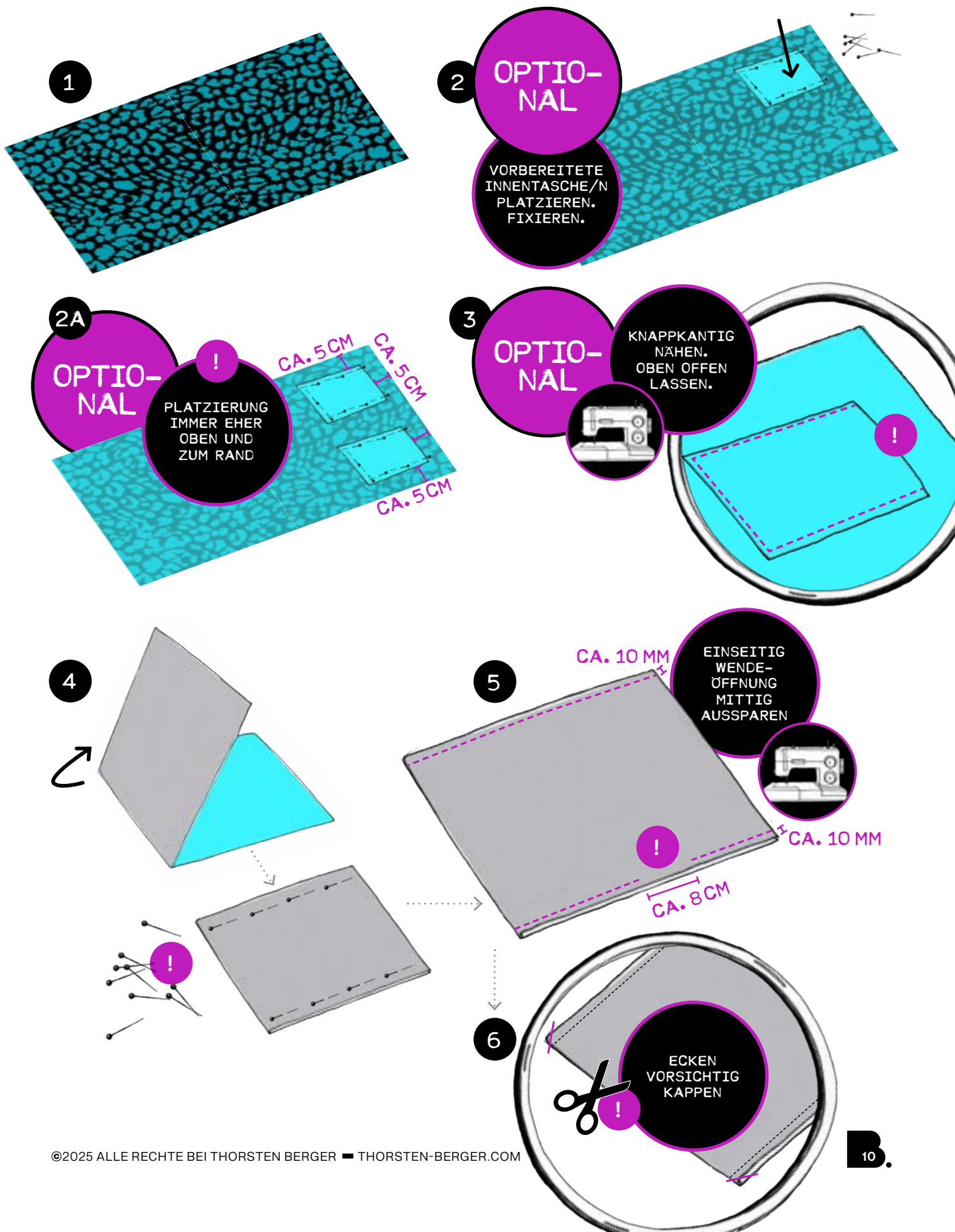

MONSTA BAG

MIX & MATCH

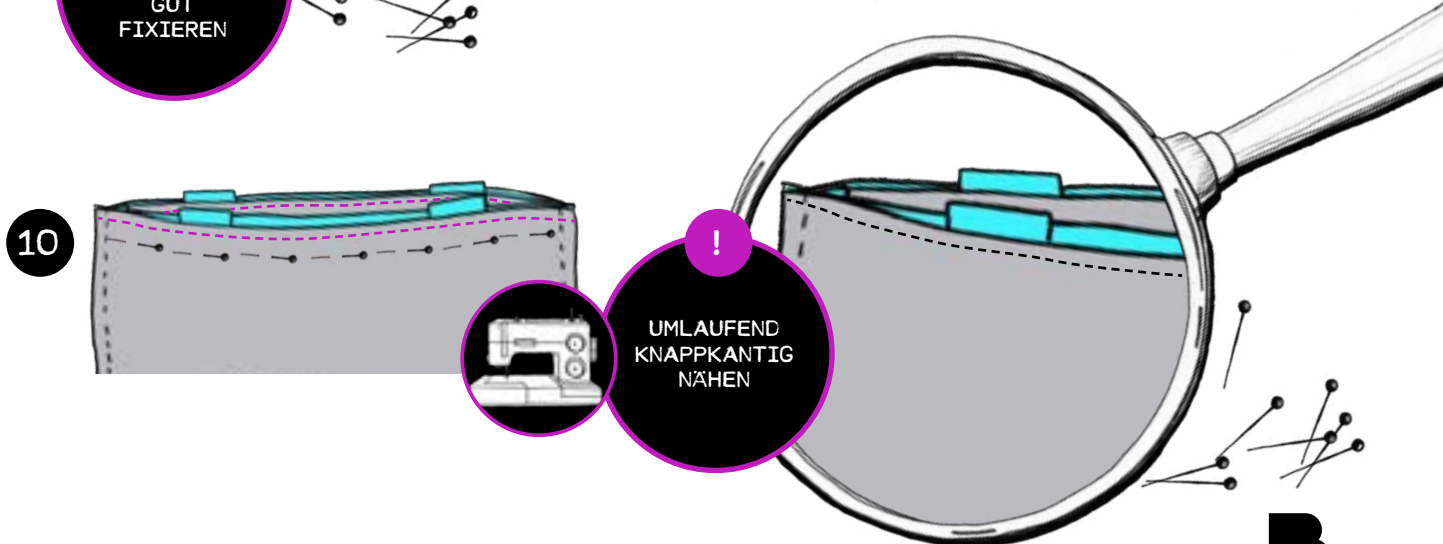
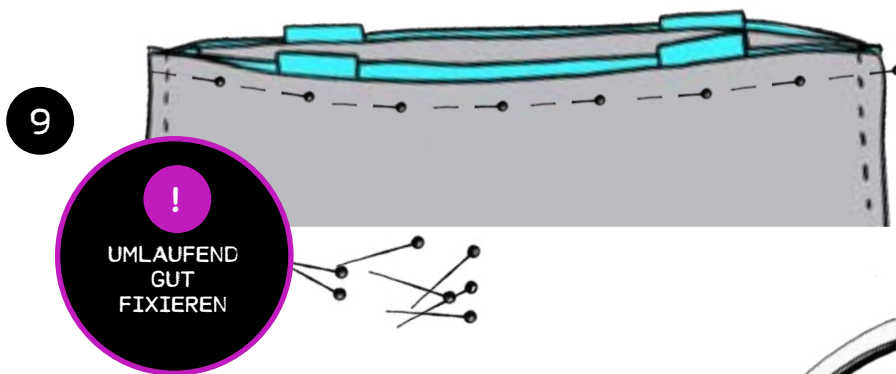
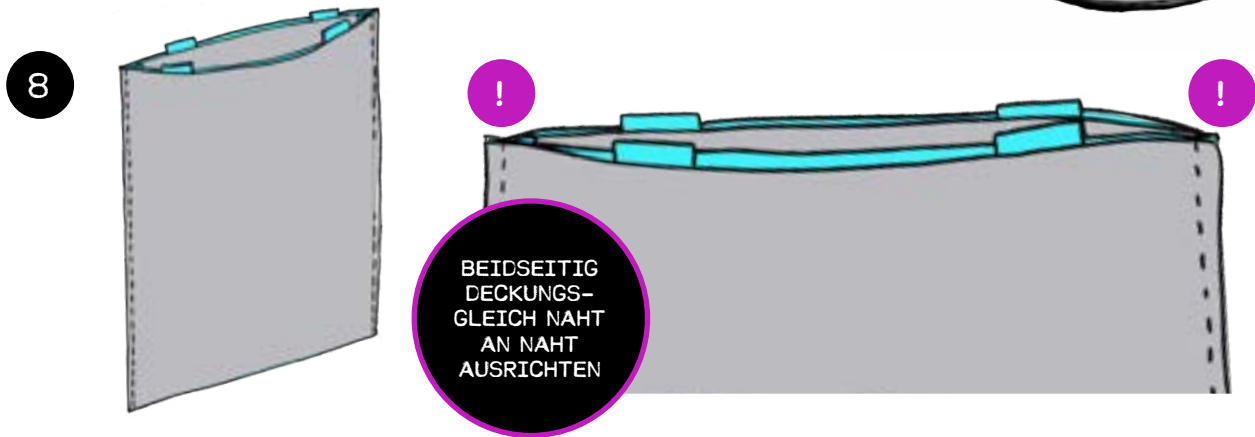
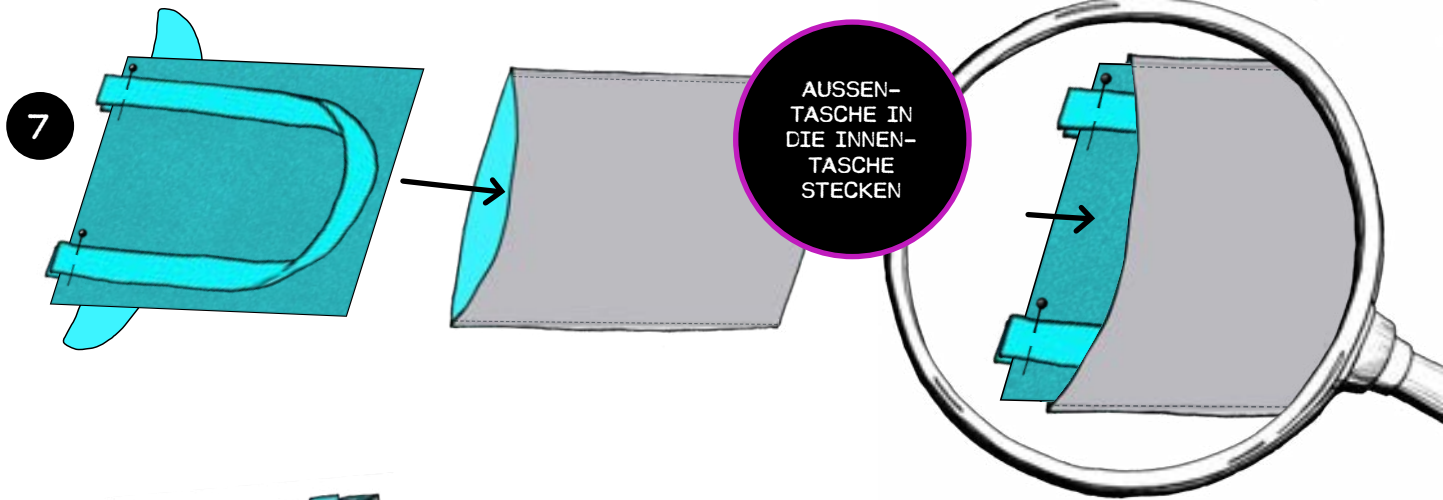

MONSTA BAG

MIX & MATCH

11

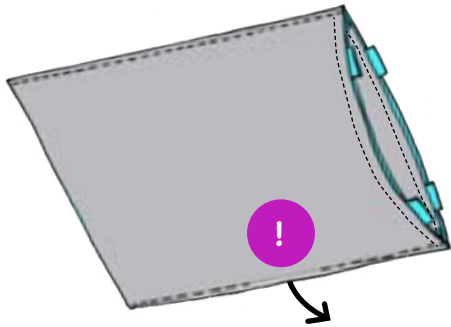

DURCH WENDEÖFFNUNG AUSSENTASCHE HERAUSZIEHEN & INNENTASCHE KOMPLETT WENDEN

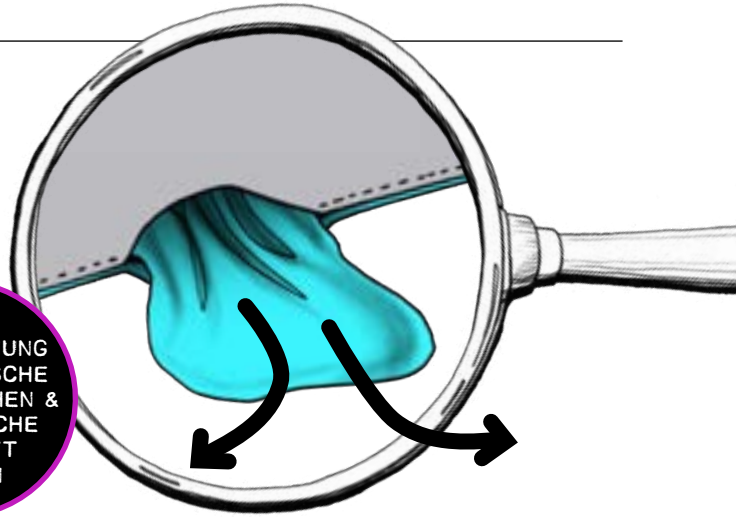

12

ACHTE AUF DIE ECKEN UND FORME SIE AUS

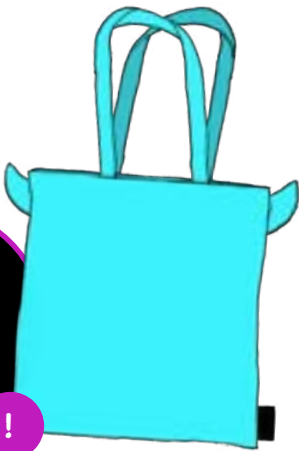

13

WENDEÖFFNUNG SCHLIESSEN. 1. NAHTZUGABE NACH INNEN UMSCHLAGEN

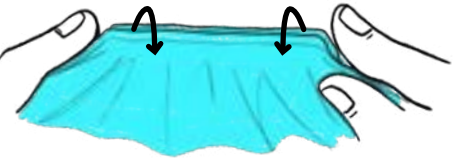

2. PER HAND ODER MIT NÄHMASCHINE KNAPPKANTIG ZUNÄHEN

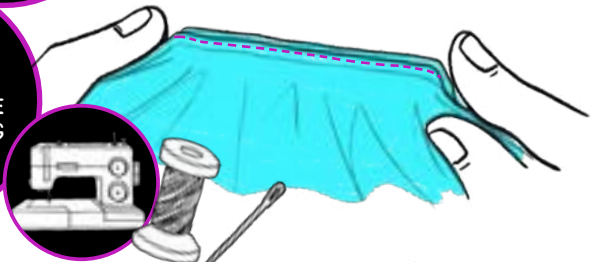

14

OBEN UMLAUFEND KNAPPKANTIG NÄHEN



FÜR MEHR FESTIGKEIT ZWEITE NAHT PARALLEL IM ABSTAND VON CA. 1CM

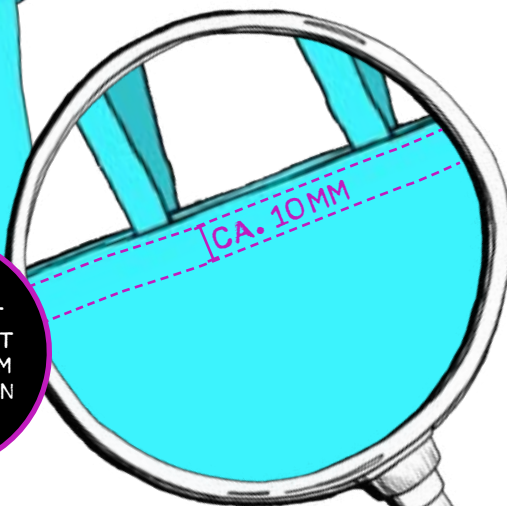

15



FERTIG :-)